



UNHCR

United Nations High Commissioner for Refugees
Haut Commissariat des Nations Unies pour les réfugiés

DATE: 22 March 2021

REQUEST FOR QUOTATION: No. 21/HCR/SDNELG/FO/RFQ/04

Furniture's for El Geneina Guesthouse

QUOTATION TO BE RECEIVED BY: 31 /March /2021 4:30 HRS

The Office of the United Nations High Commissioner for Refugees (UNHCR), established on December 14, 1950 by the United Nations General Assembly¹, requests your price quotation for El Geneina Guesthouse furniture's , as specified in this Request for Quotation (see Annex A for the specifications).

1. Requirements:

Description (Annex A): Furniture's for El Geneina Guesthouse

Financial offer form: (as per Annex: A)

- **Delivery lead time** 30 Days from order placement)
- **Delivery Place:** UNHCR El Geneina Guesthouse -Hay Al jamarek Area

Important:

- Please include the price information in your quote (without VAT) – by completing and signing attached **Annex A (specifications and Financial Offer Form)**.
- Currency: United states Dollars (**USD**) Or Sudanese Pound (**SDG**)
- Your quotation must be valid at least for **30 days**.
- The standard payment terms of UNHCR is net 30 days upon satisfactory completion of the goods and acceptance thereof by UNHCR.
- Please note that UNHCR has tax and duty **exemption** status.

¹ For further information on UNHCR, please see <http://www.unhcr.org>

- UNHCR reserves the right to accept whole the lots or partially.
- Please clearly mention the currency you are quoting for
- The official exchange rate is SDG (376) to (1) USD.
- This RFQ is only for Suppliers within Sudan, foreigner suppliers also can apply if can meet the delivery lead time
- UNHCR shall not be able to facilitate importation or provide an import duty exemption for any supplier

2. RFQ Offer Submission

We would appreciate receiving your quotation on or before **31 March 2021 – 4:30hrs** by email to the address sudefrfq@unhcr.org

On the address, please mention the following:

RFQ: 21/HCR/SDNELG/FO/RFQ/004 – Furniture's, for El Geneina Guesthouse

- **Name of your firm (Mandatory)**
- **C/o - Supply Unit**

The following annexes form an integral part of this RFQ:

- Annex A – Specification's and Financial Offer Form
- Annex B - Vendor Registration form
- Annex C - UNHCR's General Terms and Conditions for the provision of Goods and service
- Annex D - UN Supplier Code of Conduct

Please note that submitting an offer is deemed as acceptance of UNHCR's General Conditions for Provision of Goods and Services and UN Supplier Code of Conduct.



Thank you for your kind attention.

Badradin Supply unit, Darfur





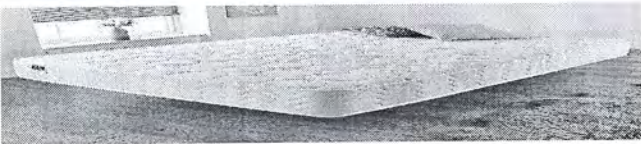

ANNEX A : SPECIFICATIONS AND FINANCIAL PROPOSAL FORM



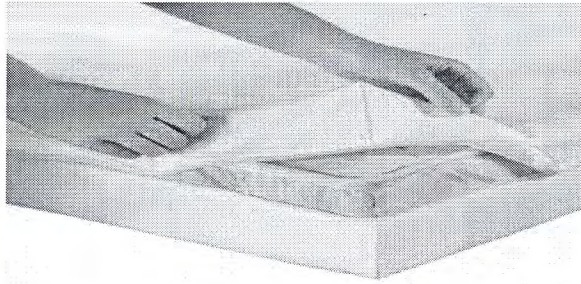

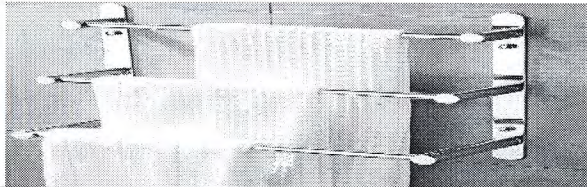
RFQ NO 21/HCR/SDNELG/FO/RFQ/04 Furnitures for El Geneina Guesthouse

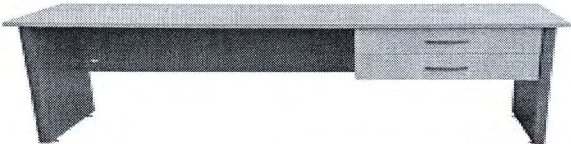
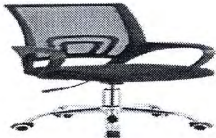
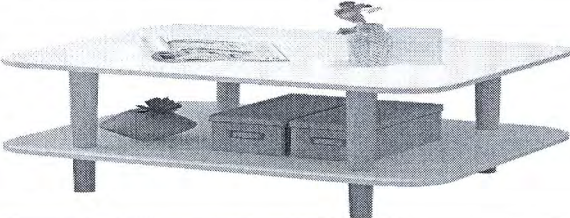

Furniture's for Master rooms							#
ITEM	DESCRIPTION	Specifications	Sample	QTY	Unit Cost	Total Cost	
1	Double Bed wooden	Bed wooden size 190x200		12		-	Life picture is required along with the offer
2	MATRESS	Spring Mattress size 200X180cm		12		-	Life picture is required along with the offer
3	PILLOWS	Internal polyester/memory Foam Cover 100%cotton,size 50X75cmcolour white		24		-	Life picture is required along with the offer

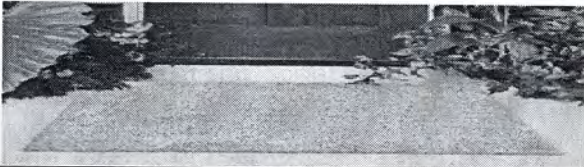

4	PILLOW CASES	standard		24		Life picture is required along with the offer
5	BED SHEETS	double size ,cotton mixed polyester assorted colors		24		Life picture is required along with the offer
6	BED COVER	Brushed Cotton ,size 300X300cm		24		Life picture is required along with the offer
7	BLANKET	6 KG ,Size 280x320 soft silk fabric		8		Life picture is required along with the offer

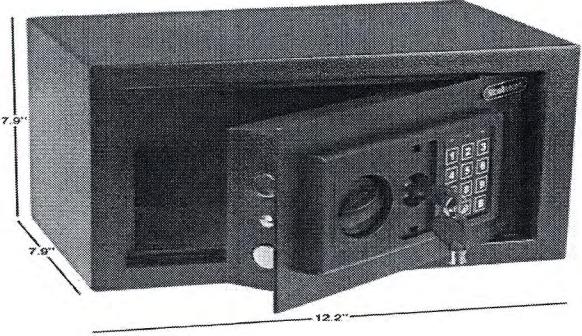

8	MATRESS PROTECTOR	Water proof size 200x180cm		12			Life picture is required along with the offer
9	MOSQUITO NET	BACKBONE Mosquito Net, Polyester Foldable King Size Bed, Double Bed, Queen Size Bed with Free Saviours (Suitable for 6ft x 6ft to 6.9ft x 6.9ft)		12			Life picture is required along with the offer
10	TOWEL RACK	stainless steel three shelves		12			Life picture is required along with the offer
11	MIRROR	60 X 45 Cm Bathroom Mirror with colored fabricated frame and towel hanger		12			Life picture is required along with the offer
12	SHOWER CURTAINS	WHITE 100% LINEN SHOWER CURTAIN (WATERPROOF) - 150CM WIDE		12			Life picture is required

							along with the offer
13	DESK	Material: Made of melamine wood. Dimensions: W120 - D80 - 85, H 70 - 75 cm. Color: Ebony Macassar or palisander, or Mocha ash or Milano walnut. With 2 drawers		12			Life picture is required along with the offer
14	CHAIR	Material: Mesh material. Padded arms. Adjustable seat height and double wheel casters for easy movement.		12			Life picture is required along with the offer
15	SIDE TABLE	Sofa Side Table Wood + Wood-based Panel, 2 Layers Of Multifunctional Simple Square Coffee Table, White, 2 Sizes (Size : 59 * 39 * 52cm)		12			Life picture is required along with the offer

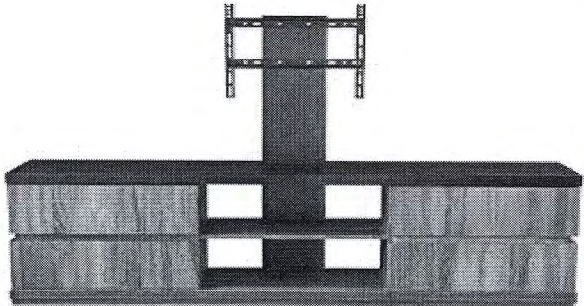
16	WARDROBE	Wooden cupboard with three doors and mirror attached in the middle		12		Life picture is required along with the offer
17	CLOTH HANGERS	wooden coat hanger stand		24		Life picture is required along with the offer
18	DOOR MAT	Nonslip outdoor mats 30 X 18 cms. Primary material: heavy-duty coir with a PVC backing to keep it in place.		12		Life picture is required along with the offer
19	SHOE RACK	3 racks, Material: Wood, Height: Between 60 -70 cm, Width between 30-35 cm, length between 60 – 80 cm		12		Life picture is required along with the offer

20-	SAFE BOX	<p>Minimum interior Dimensions: 30X20X20CM Able to be programmed with master and guest codes 3-8 digits long. Should be equipped with at least 2 manual override keys Equipped with alarm notification for incorrect code entries. Wall thickness: minimum 1.5mm, Door thickness: minimum 3mm. 4 AA batteries powered</p>		12			Life picture is required along with the offer
21	BEDSIDE LAMP	<p>White Fabric Lampshade Design Product Dimensions: 7.5 X 7.5 X 16.2 Voltage: 110V-130V Material: Metal base and frame, White fabric lampshade Weight: 2.38Lb (1.08kg) Power source: Corded Electric Light bulb included: Non- dimmable, No Harsh Light, Comfortable Feelings Switch style: Push Button</p>		12			Life picture is required along with the offer

22	COAT HANGERS	Sets of Wooden Coat Hanger with metal hook		12			Life picture is required along with the offer
23	TV table	TV table wooden with two drawers		12			Life picture is required along with the offer
24	Hangers / screws for towels in bathroom	Dual Robe Hooks Metal Hook Coat Towel Bathroom Hanger w Screw 4pcs - Bronze Tone/4pcs - 3.46 x 0.91" x 2.56"(L*W*H) (Bronze Tone/4pcs - 3.46 x		12			Life picture is required along with the offer

25	7 SEATER SOFA (GROUND FLOOR) LOBBY	<p>Sofa set shall be fully cushion leathered, including arms, wooden frame, webbing and injection molded PU foam. PU foam finished.</p> <p>Fabric: Made of genuine leaders. Rexine leather shall not be accepted.</p> <p>Dimensions: 3 seats: 200x87x 82 cm 2 seats: 140x87x82 cm 2 seat: 85x87x82 cm</p>		1			Life picture is required along with the offer
26	5 SEAT SOFA (1-2RD FLOOR) LOBBIES	<p>Sofa set shall be fully cushion leathered, including arms, wooden frame, webbing and injection molded PU foam. PU foam finished.</p> <p>Fabric: Made of genuine leaders. Rexine leather shall not be accepted.</p> <p>Dimensions:</p>		3			Life picture is required along with the offer

		2 seats: 140x87x82 cm 1 seat: 85x87x82 cm (2 unit)				
27	DINNING TABLE (SITTING 12)	DINNING TABLE (SITTING 12) wooden		1		Life picture is required along with the offer
GRANT TOTAL						

Important Note:

Interested Bidders should submit life pictures of the Goods they are proposing

Payment terms: Acceptance of UN payment terms (i.e. 30 days net from receipt of documents)

YES

NO

Offer Validity:

30 Days

YES

NO

COMPANY OR FIRM NAME

Authorized person and Title:

Signature and stamp

Date:
